



CAUTION!

Always remove drawers and doors from your cabinets during installation and store them away from the work area. This will make your cabinets lighter, easier to move and position, and safer to handle. Plus, drawer and door faces will be protected from damage during installation.

Drawers and doors open when you don't expect it and unbalance the cabinet while you are moving it, causing injury or damage.

Damage caused during installation is not covered by warranty.

Installing Vanities

The key to a good installation of a vanity ensemble is to understand that walls and floors are never exactly level, plumb, or square. Securing a cabinet to a wall that is out of plumb to the floor or in a corner that is not square can distort the cabinet box and cause drawer and door hardware to misalign. While our hardware is fully adjustable to compensate for this visually, the drawers may not open and close smoothly. **Never** close a gap by overly tightening the securing screws. Use a shim between the cabinet and wall before tightening.

Place your cabinets into approximate position. Clamp components together making sure that they are accurately mated and the top edges are exactly aligned. Drill pilot holes and screw components together. We recommend four screws per pairing.

Place the ensemble into exact final position and level,  shimming underneath where necessary. We recommend screwing to wall studs in at least two positions along the back and one in the side, if the side is against a wall. Shim where necessary between wall and cabinets if the wall is not exactly straight or plumb.

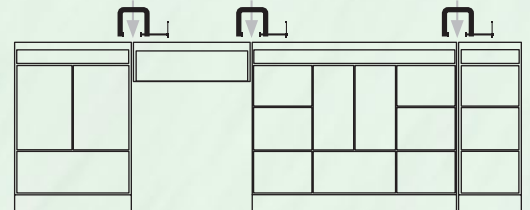

Installing Linen Uppers

Linen Uppers are always packed "upside down" to prevent damage to the doors that overhang the frame. The doors will cover the joint where the upper and lower units join. Cut away the box and remove inner wrappings. Remove all wood shipping supports LEAVING IN PLACE THE 90° ANGLE BRACKETS. These brackets will fit inside the lower unit and will be used to secure the Linen Upper to the Linen Lower. Remove the doors and place well away from your work area.

Always have two people lift and position the Linen Upper onto the Linen Lower. Make sure connecting brackets clear Linen Lower edges and fit into place. Adjust the two Linen halves to mate exactly. From inside the Linen Lower, Carefully drill pilot holes and secure brackets with provided screws.



Re-install Doors and Drawers

Once your cabinets are in their final positions and secured, re-install and adjust doors and drawers according to directions on the next page. You will need to peel the protective film from **Gloss White** finish doors and drawer faces.

6-Way Adjustable Hinges

Installing, removing, and adjusting your Cabinet doors is easy with our 6-way adjustable hinges.

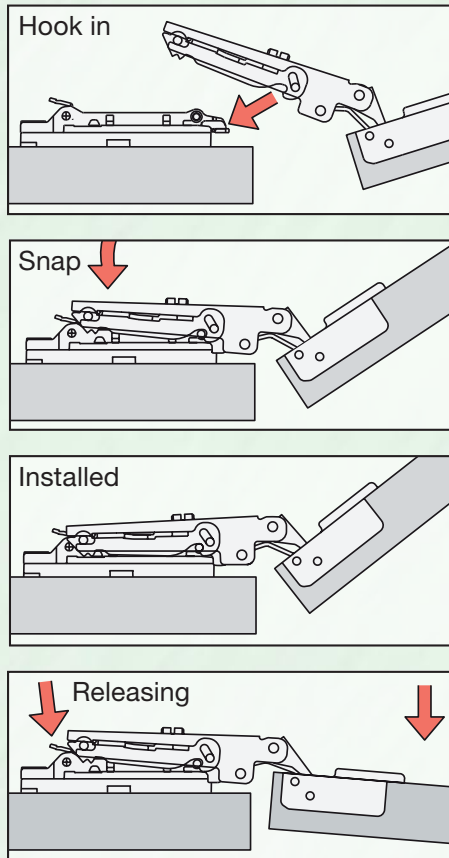

Loosen indicated screws on both hinges to adjust door up/down. **Never** adjust one hinge without also adjusting the other hinge.

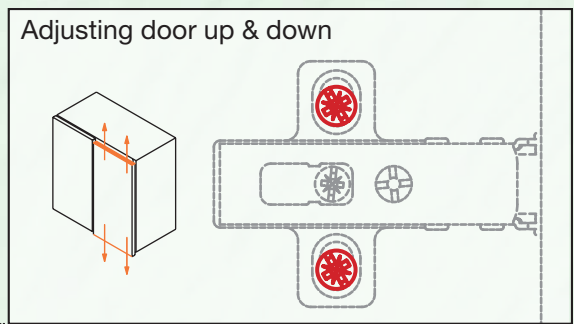

Simply turn indicated screw to adjust door in/out.

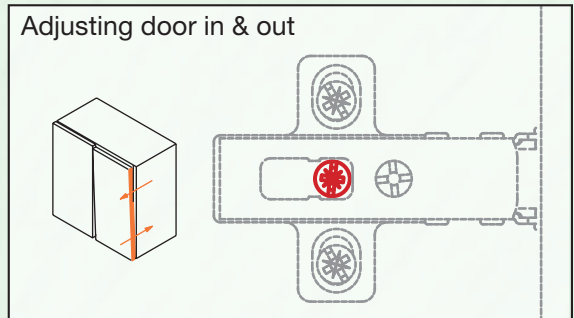

Simply turn indicated screw to adjust door left/right.

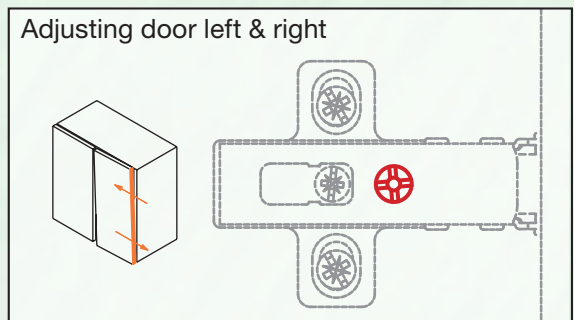

Drawer Face Adjustment

Loosen the four drawer guide mounting screws and adjust drawer face sideways. To raise, lower, or level drawer face loosen locking screw(s) and turn adjusting screw(s), on either side or both. Remember to tighten the locking screw when done.

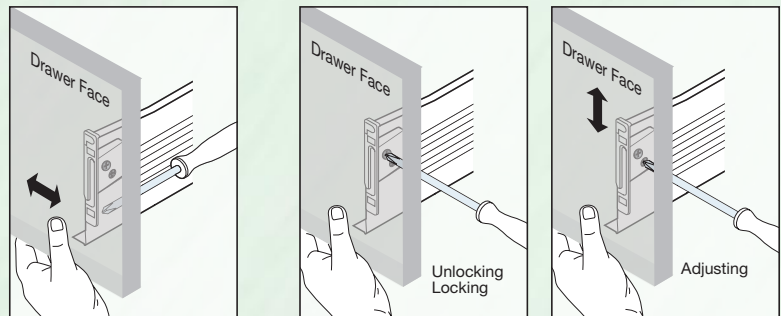

Cleaning

Use only a damp cloth to clean your Bath Cabinets.

Never use abrasive cleansers on any part of your Bath Cabinet and use only a soft cloth, never a scouring sponge. Never use bleach, solvents (like nail polish remover), or harsh cleaners on your cabinets.

If you have questions, don't hesitate to call our Customer Service
Toll Free 1-800-445-0494, 7AM-4PM Pacific Coast Time.

Thank you for purchasing Strasser Woodenworks Products for your bath.

Crafted in USA. Lasting a Lifetime.

